

SPECIFICATION		
1	Model No.	YD87-10-8F45P-R
2	Dimension:	87*87*28H mm
3	Cone Material:	Paper
4	Edge:	Paper
5	Nominal Power:	2W
6	Maximum Power:	3W
7	Impedance:	8Ω±15%Ω
8	Voice coil:	Φ13.28mm PL+Cu
9	Fo:	230±20%
10	Response:	Fo~10KHZ
11	S.P.L.:	94±3dB(AT 0.1W/0.1M,Average of 0.6.0.8.1.0.1.2 KHz)
12	Magnet Size:	Φ45*22*8mm
13	Net weight:	121g±8%

THIS DOCUMENT CONTAINS DATE
 PROPRIETARY TO PROJECTS CHANGZHOU ESUNTECH
 CO LTD. ANY USE OR REPRODUCTION,IN ANY FORM,
 WITHOUT PRIOR WRITTEN PERMISSION OF
 PROJECTS CHANGZHOU ESUNTECH CO LTD
 IS PROHIBITED.
 ©2003,Project Changzhou Esuntech Co Ltd

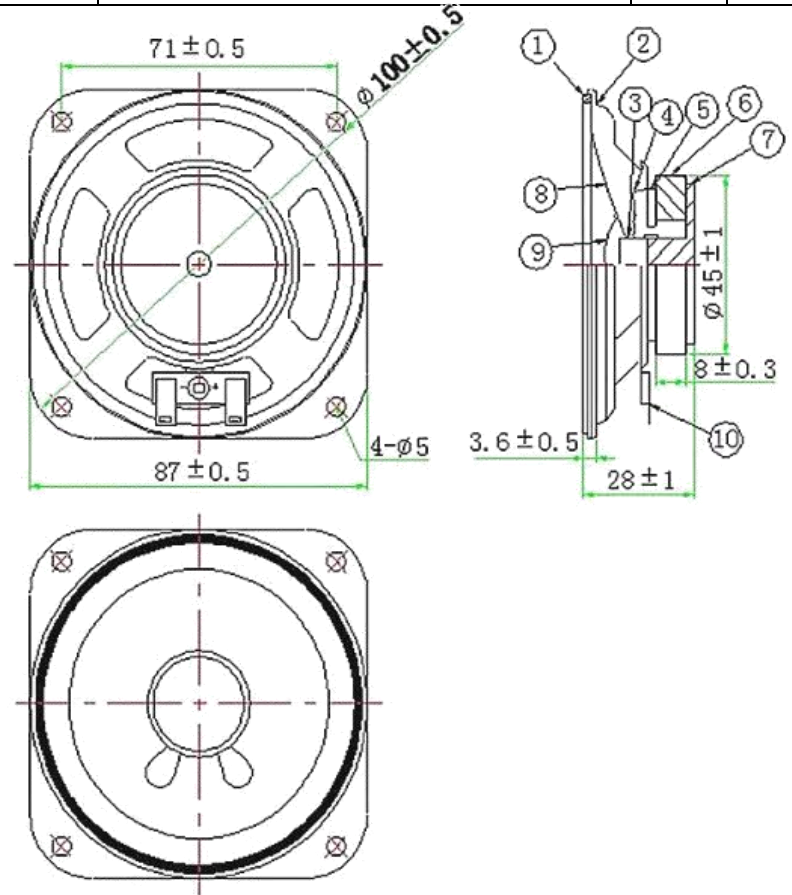

REVISION HISTORY			
LTR	DESCRIPTION	DATE	APPROVED
-	RELEASED FROM ENGINEERING	9/23/2003	Y M
A			
B			
C			



NOTES:
 1.ALL DIMENSIONS ARE IN MILLIMETERS
 2.SPECIFICATIONS SUBJECT TO CHANGE
 WITHOUT NOTICE

UNLESS OTHERWISE SPECIFIED. DIMENSIONS ARE IN MILLIMETERS TOLERANCES ARE +/-0.5 AND ANGLES ARE +/-3°	SIZE	Designed by	Date	Checked by	Date	Approved by	Date	Drawed date
	A4	 Changzhou Esuntech Co.,Ltd http://www.esuntech.com.cn		YD87-10-8F45P-R			Loudspeaker	Edition
YD45-01-8F32P-R								